

Article number: 0101234
 Description: Retaining ring A 560 DIN 471
 Spring steel
 Note: Fitted with ZGA pilers

Measures

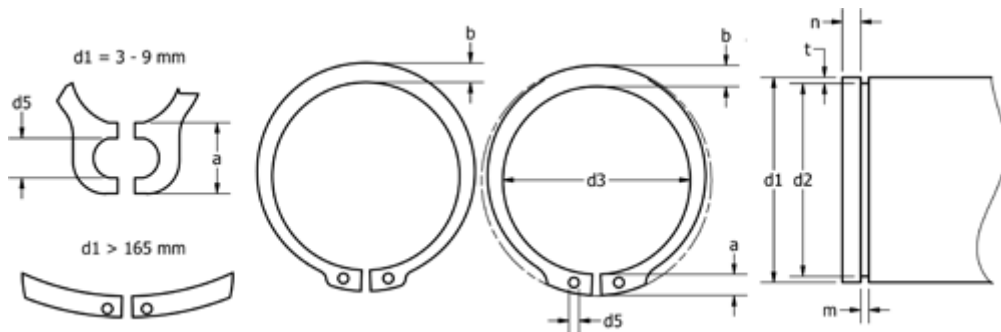

a max	=	FN kN	= 2026.0	s	= 8.00
AN mm ²	= 12161.0	FRg kN	= 153.00	t	= 7.00
b	= 26.0	FR kN	= 1777.00	tol	= -1.00
d1	= 560	g	= 7.0	tol	= -0.15
d2	= 546.0	K kN-mm	= 4071.00	tol	= +1,50-3,00
d3	= 535.0	m min	= 8.20	Tong	= ZGA-7
d5 min	= 6.0	n abl x 1000	= 0.4	Weight kg/1000	= 999.999
Description	= A560	Nominal drive	= 21.0		